

Finding Optimal Probabilistic Generators for XML Collections

Serge Abiteboul, Yael Amsterdamer, Daniel
Deutch, Tova Milo, Pierre Senellart

To appear in BDA 2011

Adding probabilities to an XML Schema

- The Web is full of semi-structured documents
- Given a collection of XML documents, we would like to have **a schema** the documents conform to.
 - E.g., DTD or XSD
 - Restricts the structure, mostly parent-child node relations (using regular expressions)
- The schema may be very general (e.g., xhtml, RSS)
- We want to add probabilities to 'guide' the schema
 - Optimal probabilities – maximize the likelihood of a corpus

Motivation

Implementation Idea: XML Editor Auto-Completion

- Based on previous document versions / corpus of user documents / corpus of example documents –
- Suggest nodes / sub-trees / node values to the user
- For example:
- **Challenges:**
 - Allow editing in every part of the document
 - What kind of completion to suggest?
 - Finding the top-k best completions

```
<MyPapers>
  <Paper>
    <title>Provenance Minimization</title>
    <author>Yael A.</author>
    <author>Daniel D.</author>
    <author>Tova M.</author>
    <author>Val T.</author>
  </Paper>
  <Paper>
    <title>Provenance for Aggregates</title>
    <author>Yael A.</author>
    <author>Daniel D.</author>
    <author>Val T.</author>
  </Paper>
  <Paper>
    <title>  </title>
    <author>  </author>
    <author>  </author>
    <author>  </author>
  </Paper>
</MyPapers>
```

Many Other Usages for a Probabilistic Schema

- **Testing** – e.g., generating many XML messages to simulate network load and test system performance.
- **Explaining** – e.g., the probabilistic schema for DBLP shows which types of publications are rarely used, which kinds of attributes are not filled for BibTex, etc.
- **Querying** – e.g., finding the probability that a paper has more than 3 authors.
– e.g., finding the top-k best completions to a partial document.
- **Schema Evaluation** – how well a given schema describes a given corpus.

Our solution - An Outline

Preliminaries – Tree Automata

Generators for Schemas without Constraints

Adding Constraints

Restart Generators

Continuation-Test Generators

Leaf Values

Using a Tree Automaton for Schema Verification

An XML document is modeled as an ordered tree.

Document d_0 :

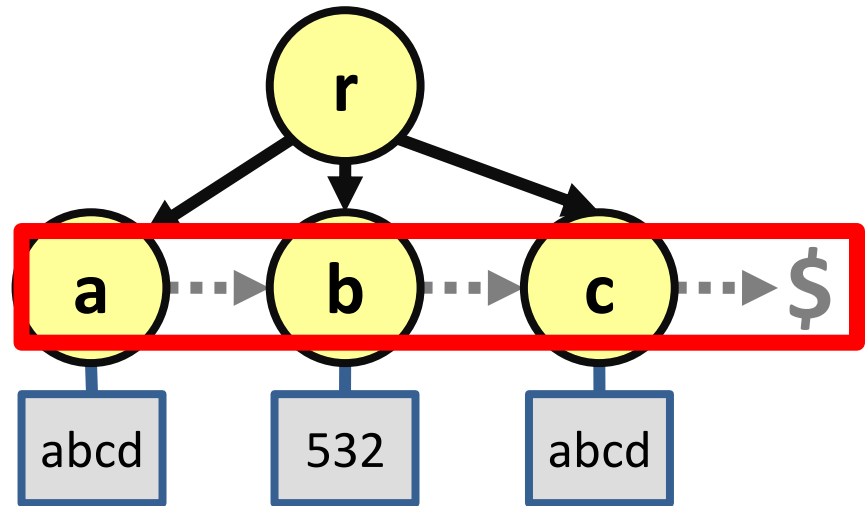

The children of a -labeled node are **accepted** by

DFA A_a

Automaton A_r : $(L(A_r) = a^*bc^*\$)$

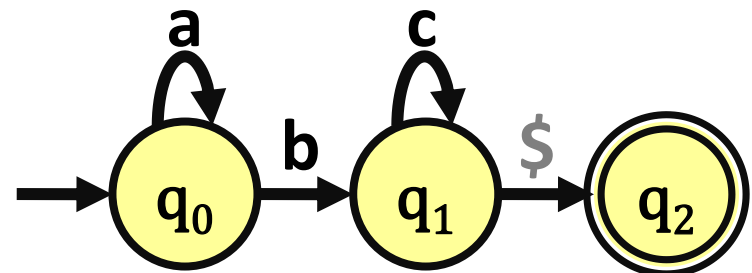

This is done for every inner node in a fixed order (BF-LTR)

Without Constraints

Using the Schema as a (Probabilistic) Generator

- Each transition is assigned a probability

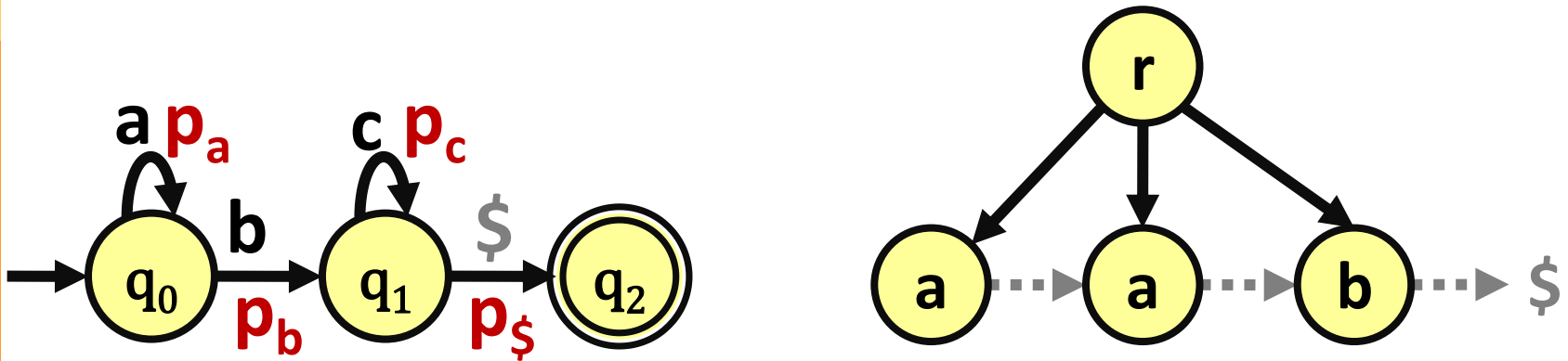

- We assume **independent choices**, thus the document probability is the product of all t-probs.
- Thus, $PR(d) = p_a \cdot p_a \cdot p_b \cdot p_{\$}$
- The schema and generator ignore leaf values (for now!)

Without Constraints

An Algorithm for Probabilities Learning

The frequency each transition is chosen during the corpus verification process is recorded.

(q_0, a)	1
(q_0, b)	1
(q_1, c)	1
$(q_1, \$)$	1

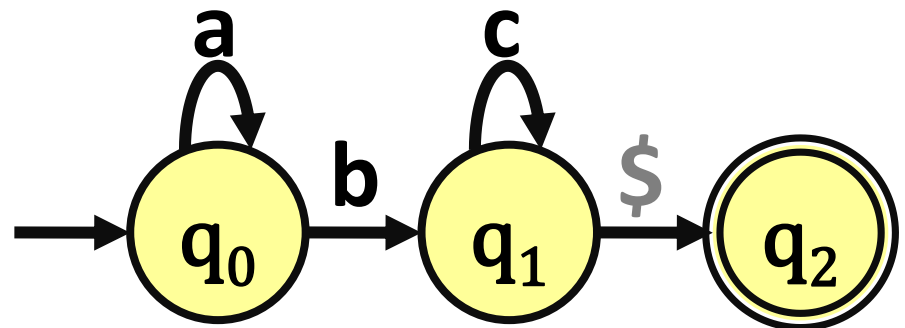
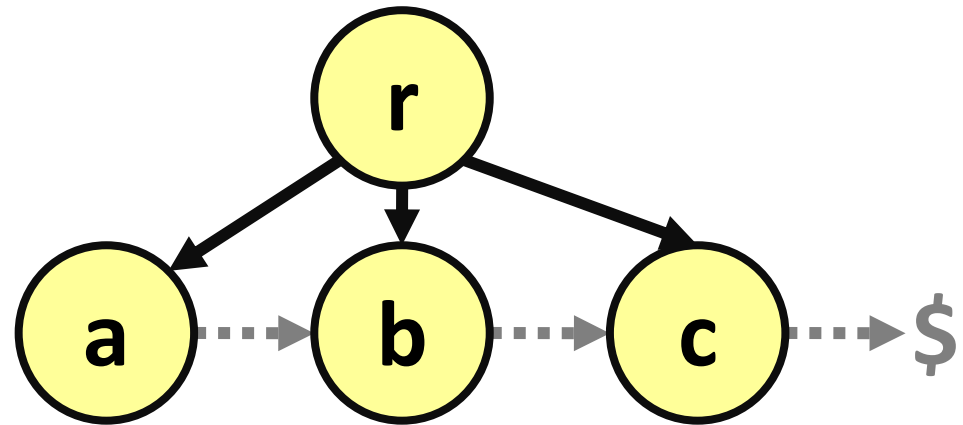

An Algorithm for Probabilities Learning (Cont.)

This is repeated for every node in every corpus document.

We set the probability of each transition to be its **relative frequency**.

These probabilities **maximize the likelihood** of generating the corpus – optimal generator (similar result in PCFGs)

(q_0, a)	$1/2$
(q_0, b)	$1/2$
(q_1, c)	$1/2$
$(q_1, \$)$	$1/2$

- Relative frequencies make **optimal** probabilities.
- Optimal probability learning and document generation can be done **efficiently**.
- Additional non-trivial result:
Generation **terminates with probability 1**.
 - Guaranteed because of the choice of probabilities according to the corpus.

- We want to allow the use of the following constraints in the schema:
 - **Key Constraint:** the leaves of a -labeled leaves have unique values (unary key)
 - **Inclusion Constraint:** the values of a -labeled leaves are contained in those of b -labeled leaves
 - **Domain Constraint:** the values of a -labeled leaves belong to some (finite or infinite) domain

- A naïve idea:
 - Use a probabilistic generator to generate a document
 - Check if it has a value assignment valid w.r.t. the constraints
 - If not, 'restart' and try again until a valid document is generated
- **Good news:** Checking the existence of a valid assignment is in PTIME
- **Bad news:** number of restarts can be **unboundedly large** in an optimal generator
 - A different quality measure for restart generators?

Adding Constraints

Continuation-test Generators

- Never make choices that lead to a 'dead end', thus always generate a valid document.
- We use a **binary test** to check if a choice has a continuation.
- Add to the schema of d_0 the constraints:
 - c is included in a
 - c is unique
- The generation process:

$$\Pr(d) = p_a \cdot p_b \cdot p_c \cdot 1$$

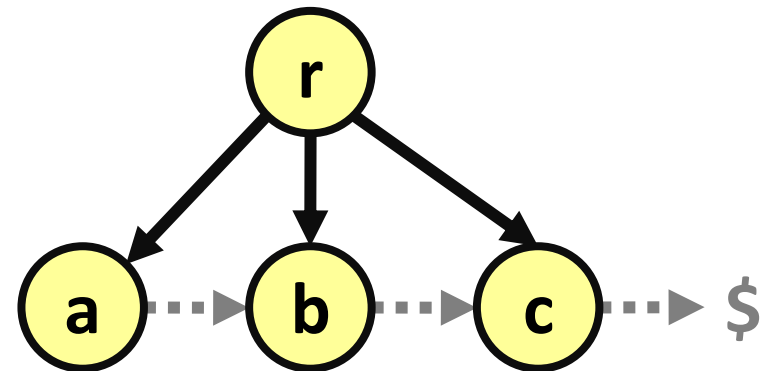
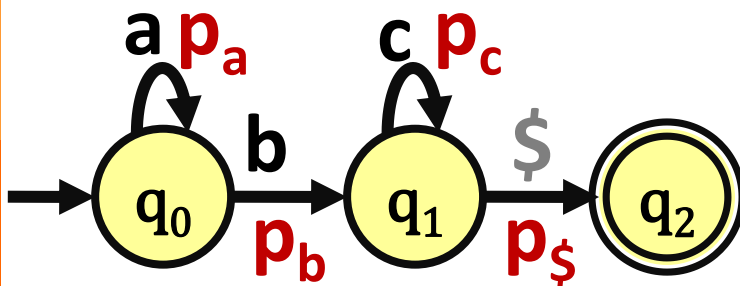

Adding Constraints

Algorithm for Learning Probabilities with Constraints

- The probabilities are again relative frequencies, but –
only in cases where there was an alternative choice.

(q_0, a)	$1/2$
(q_0, b)	$1/2$
(q_1, c)	$1/1$
$(q_1, \$)$	$0/1$

$(q_1, \$)$ was chosen only when (q_1, c) was not available.

- The learned generator will generate as many c -s as a -s

- The algorithm learns **an optimal** continuation-test generator, for automata with **binary choices**.
 - Extensions to non-binary are discussed in the paper
- **Bad News:** Continuation-test is **NP-Complete**
 - But only in the size of the schema; it is polynomial in the document size (not so bad?)
 - Based on schema satisfiability test [David et al. 2011]
- **More Bad News:** probability of termination may be **arbitrarily small!**
 - Even for simple, non-recursive schemas
 - Can be handled by adding a constraint on the document size.
 - Sub-classes of schemas that guarantee termination?

- We start with a valid document skeleton

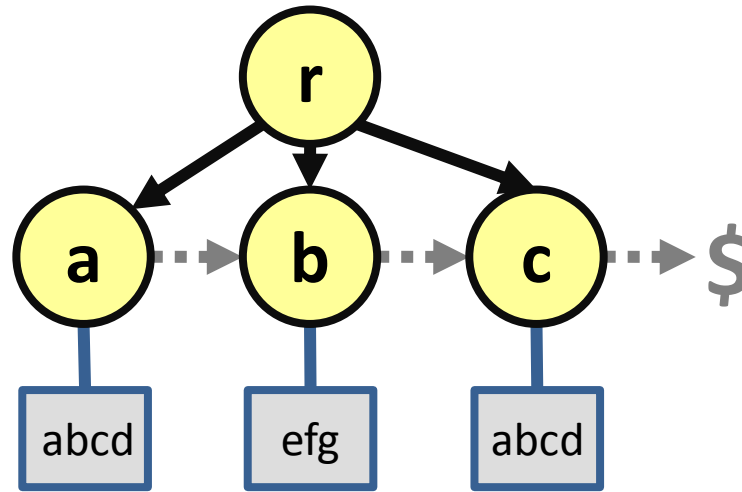

- Order labels by inclusion constraints (e.g., **c, b, a**)
- Choose a leaf from the 'smallest' (most included) label, and including leaves
- Draw a value (from the domain) according to a **given distribution**.
- Use PTIME test to verify validity, if not revert the step

Possible improvement to the basic algorithm

- Annotate the leaves with 'old' or 'new'

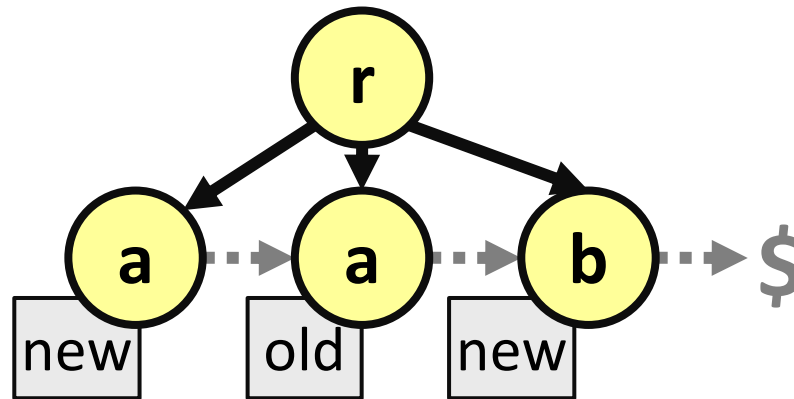

- For 'old' a -labeled leaves choose values already chosen for some a -labeled leaf
- For 'new' choose a value unused by a -labeled leaves yet
- Annotations can be learned from the corpus, and generated:
 - **Offline** – after the document generation, using a PTIME validity test
 - **Online** – during document generation, using a continuation test.
 - Both methods are incomparable in terms of quality

Ideas for Experimental Study on Probabilistic generators

- How many schemas in practice may require continuation tests?
- How many have termination probability < 1 ?
- Continuation test is expensive, but how expensive is it in practice?
- 'Competition' between restart and continuation-test generators
- More?

Thank You!

Questions, Ideas?...